

OA92 Series

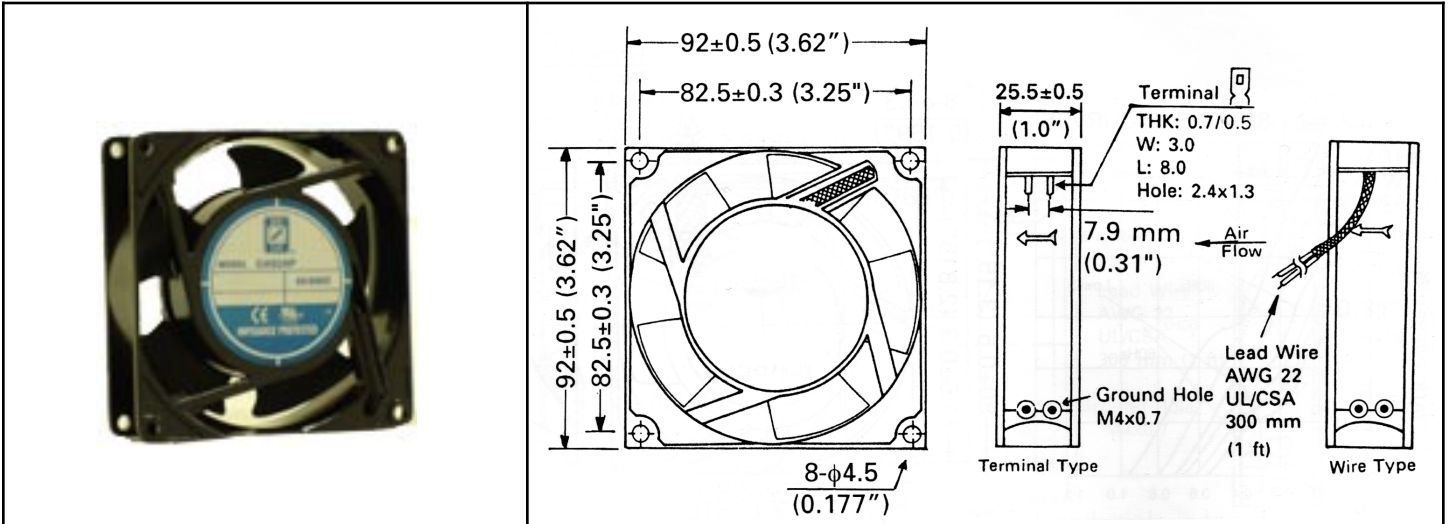

AC Fan - 115V, 230V, Dual Voltage
92 x 25mm(3.62" x 1.0")



Frame	Diecast Aluminum	<p><u>Operating Temperature</u> Ball Bearing -20C ~ +80C Sleeve Bearing -10C ~ +50C</p> <p><u>Life Expectancy</u> Ball Bearing 60,000 hours (L10 at 40C) Sleeve Bearing 30,000 hours (L10 at 40C)</p> <p><u>Dual Voltage</u> Connection via 4x leads. Fans can be configured for 115V or 230V operation.</p>	
Impeller	PBT, UL94V-O plastic		
Connection	2x Lead Wires 22 AWG or terminals		
Motor	Shaded pole, impedance and thermally protected		
Bearing System	Dual ball or Sleeve		
Insulation Resistance	>100M ohm between lead-wire and frame (500VDC)		
Dielectric Strength	1 min at 1500 VAC, 50/60Hz		

Model Number	Speed (RPM)	Airflow (CFM)	Noise (dB)	Volts AC	Voltage Range	Watts	Max. Static Pressure ("H2O)
OA92AP-11-1*	3000	35	30	115	80~130	13	.20
OA92AP-11-2*	2300	27	22	115	80~130	10	.14
OA92AP-11-3*	1600	21	19	115	80~130	6	.09
OA92AP-22-1*	3000	35	30	230	160~260	13	.20
OA92AP-22-2*	2300	27	22	230	160~260	10	.14
OA92AP-22-3*	1600	21	19	230	160~260	6	.09
OA92AP-11/22-1W**	3000	35	30	115/230	80~260	13	.20
OA92AP-11/22-2W**	2300	27	22	115/230	80~260	10	.14
OA92AP-11/22-3W**	1600	21	19	115/230	80~260	6	.09

* Indicate "TB" (Terminal Ball Bearing), "WB" (12" Wire Leads, Ball Bearing), "TS" (Terminal, Sleeve Bearing), "WS" (12" Wire Leads, Sleeve Bearing)
** Indicate "B" (Ball Bearing) or "S" (Sleeve Bearing)